

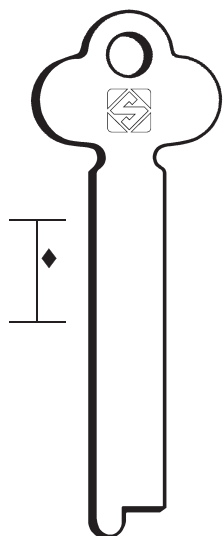

Mail Box and Lift Keys
Chiavi per casellari e ascensori
Fachkästen-und Liftschlüssel
Clés pour casiers et ascenseurs
Llaves para casillas y ascensores
Chaves para caixas de correio e elevadores

PER:
FOR:



1001

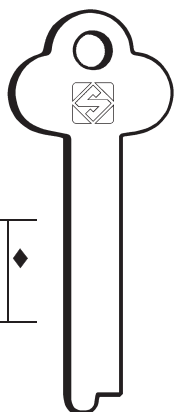

1000

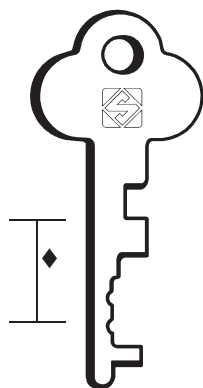

1003P

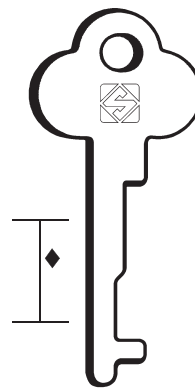

1003P1



243

PER / FOR

CISA (I)

I.B.F.M (I)

J.BEER (GB)
YALE (244)

MILES (RUS)

RIL (P)

SARGENT (USA)

SERRETA (E)

UNION (GB)

PER:
FOR:

CISA

I.B.F.M

MILES

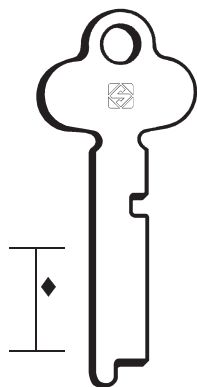

CS1003

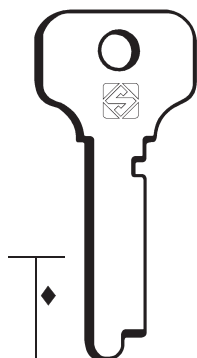

1002

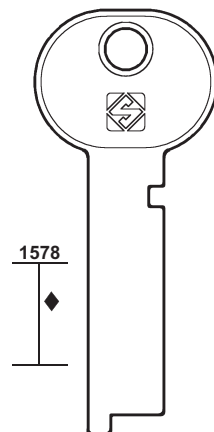

MIS1

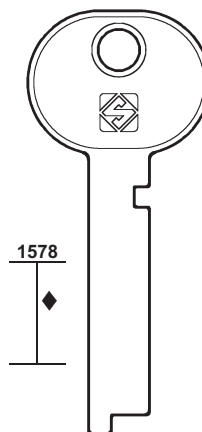

MIS2

PER:
FOR:

RIL

SARGENT

SERRETA

UNION

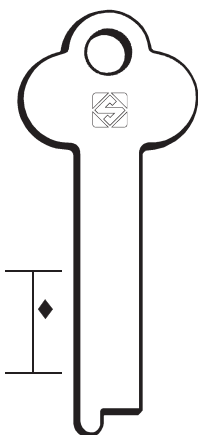

RL1

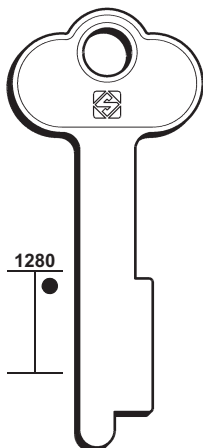

SAR1031

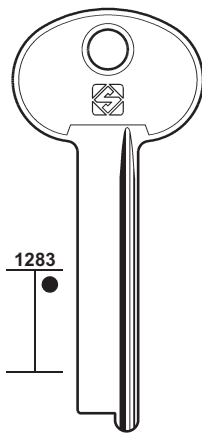

SAR1032

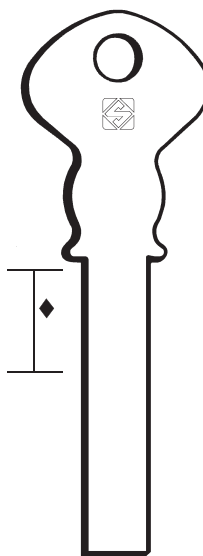

CX7

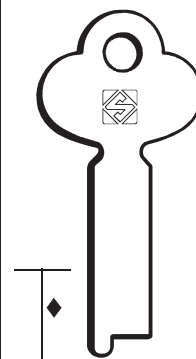

UNI1010



244

PER / FOR

YALE (GB)
J. BEER

CASELLARIO (I)

COUILLET (F)

CUIRASSEE (F)

PER: YALE
FOR:

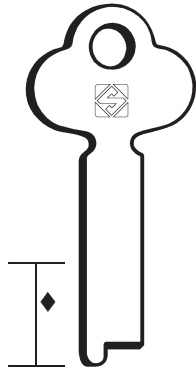

YA1007

J. BEER

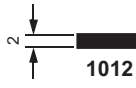
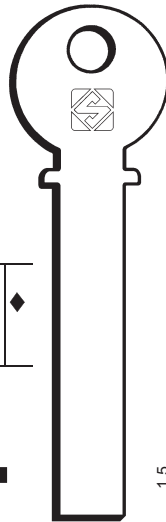

1012



1013



1015



1016 ▲

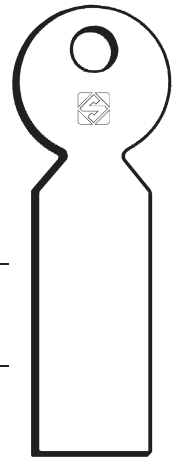

1014

PER: COUILLET
FOR:

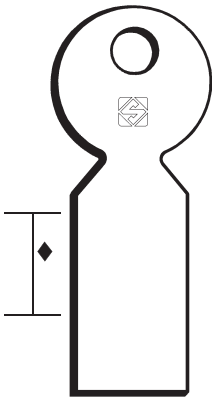

CU402



CU405

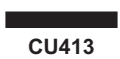

CU413

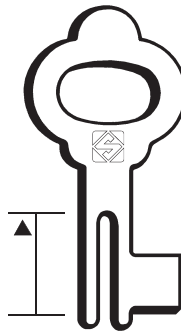

1008



1009

CASELLARIO

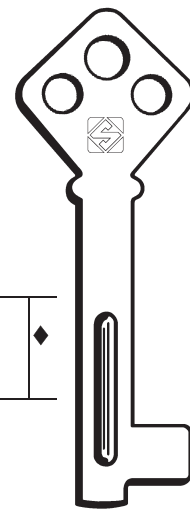

1004
Right/Destro



1005
Left/Sinistro

PER: CUIRASSEE
FOR:

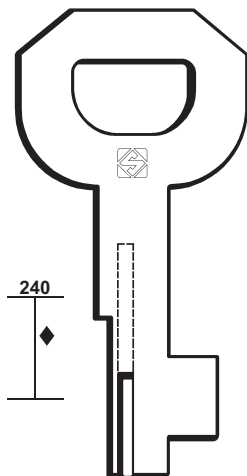

CRE401



CRE402



CRE403

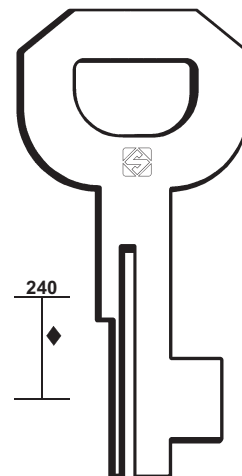

CRE404



CRE405



CRE406

PER:
FOR:

MOBELLAS

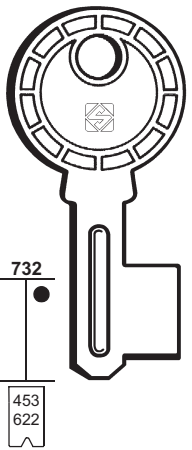

MBS300
 (SER11) 22001-22750
 (SER12) 17501-18250
 (SER13) 16001-16750
 (SER14) 18251-19000
 (SER15) 16751-17500
 (SER21) 11501-12250
 (SER22) 24251-25000
 (SER23) 10751-11500
 (SER24) 12251-13000
 (SER25) 10001-10750
 1-2-3-4-5
 1-2-3-4-5

MBS301
 (SER11) 40751-41500
 (SER12) 36251-37000
 (SER13) 34751-35500
 (SER14) 37001-37750
 (SER15) 35501-36250
 (SER21) 30251-31000
 (SER22) 43001-43750
 (SER23) 29501-30250
 (SER24) 31001-31750
 (SER25) 28751-29500
 1-2-3-4-5
 1-2-3-4-5

PER:
FOR:

MUEL

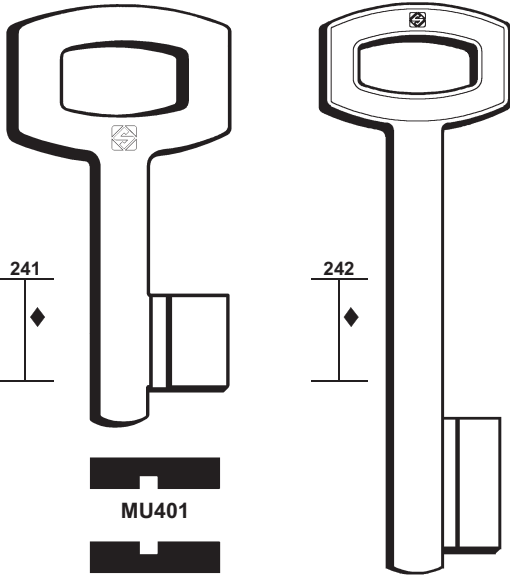

MU401
MU402

MU403
MU404

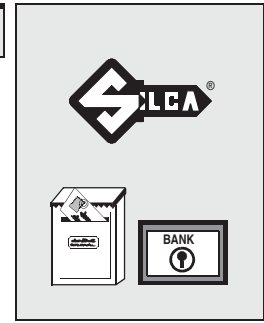

245

PER / FOR
MOBELLAS (S)
MUEL (F)
BODE (D)
HEERUM (D)
KROMA (D) OSTERTAG (245)
OSTERTAG (D) KROMA
STUV (D)

PER:
FOR:

BODE

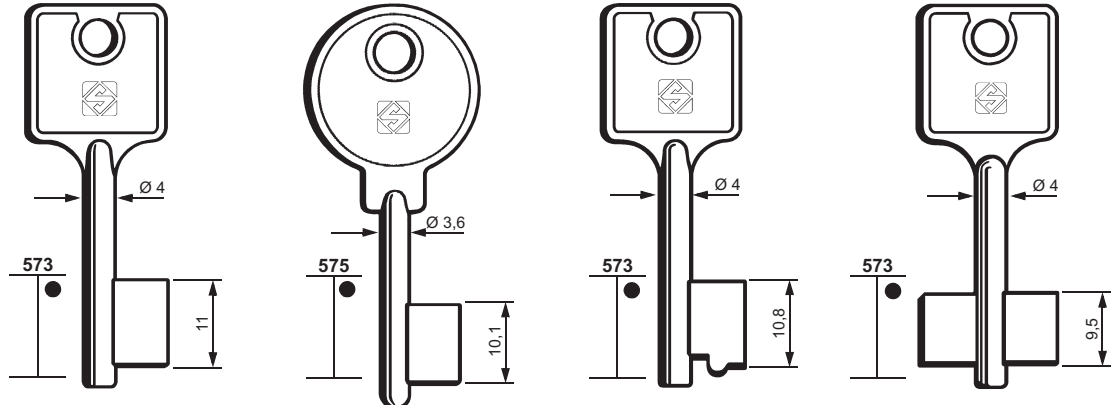

6BDE1 **6BDE2** **6BDE3** **5BDE1**

PER:
FOR:

HEERUM

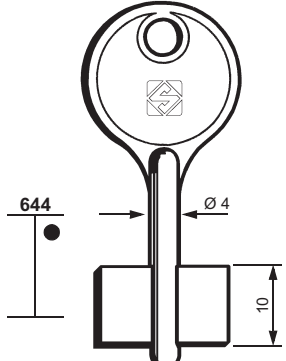

5HRM1

PER:
FOR:

OSTERTAG

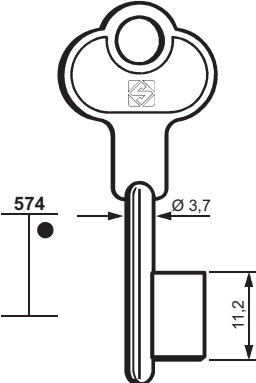

6OG1

KROMA

PER:
FOR:

STUV

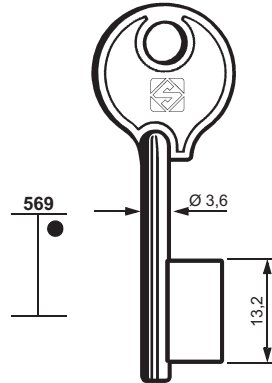

6SV1



246

PER / FOR

BASSETTI (I)

BELLOMO (I)
STIGLER (247)

BONFEDI (I)

BOSISIO (I)

FALCONE (I)

FIAM (I)

INSUBRIA (I)

PER:
FOR:

BASSETTI

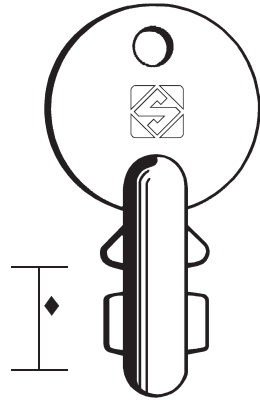

ABA1

BONFEDI

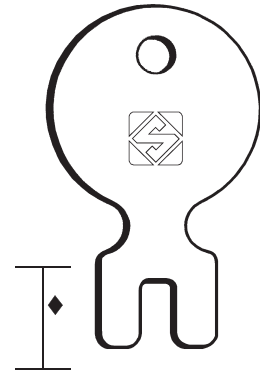

ABO1
Modified/Modificato

PER:
FOR:

BONFEDI

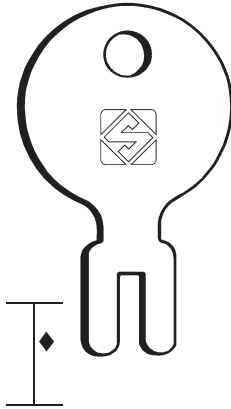

ABO2
Normal/Normale

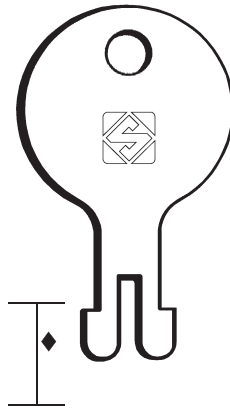

ABO3
To cut out/Ritagliato

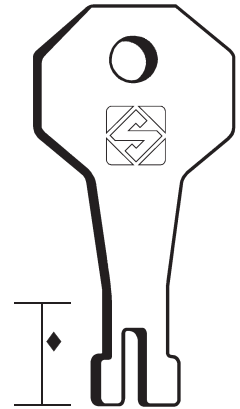

ABO4

PER:
FOR:

BOSISIO

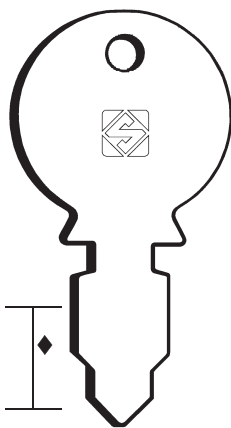

ABOS1

FALCONE

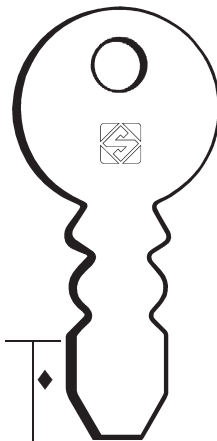

AFA1

FIAM

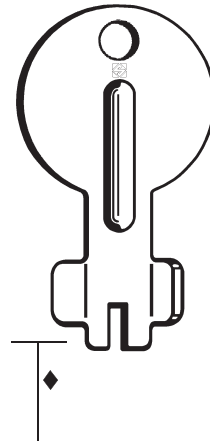





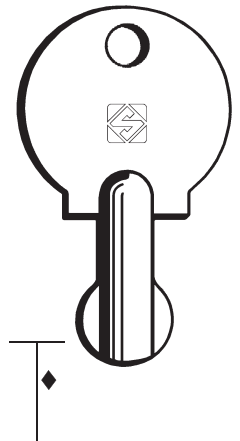

AF1
Universal/Universale

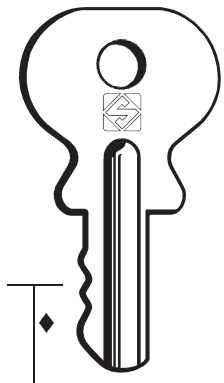
INSUBRIA

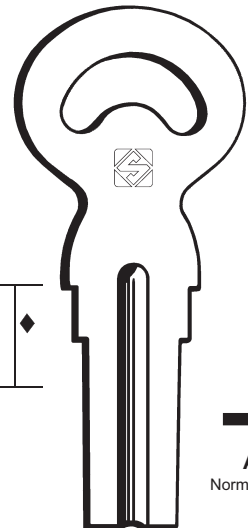

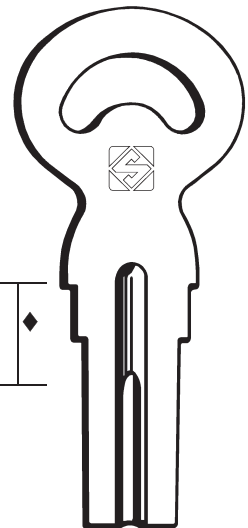



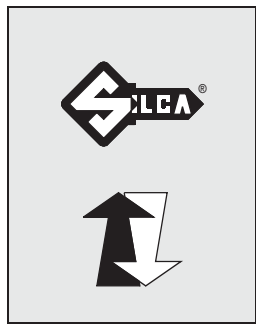

AIN1



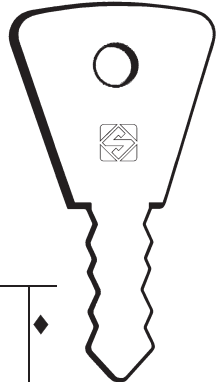

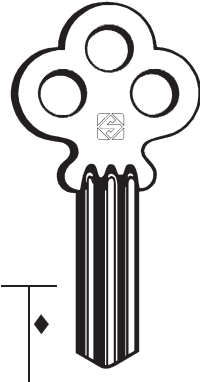
PER: FOR: MANETTI	PERINO	
  AMA1	  APE1 Normal/Normale	  APE1F

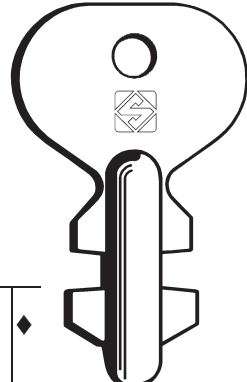

247

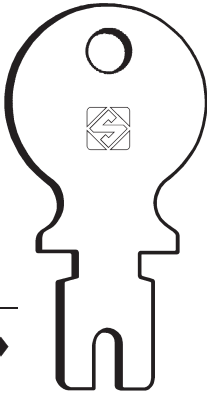
PER / FOR
MANETTI (I)
PERINO (I)
ROMA (I)
SABIEM (I)
SAFOV (I)
S.I.C.E.M. (I)
STIGLER (I) BELLOMO

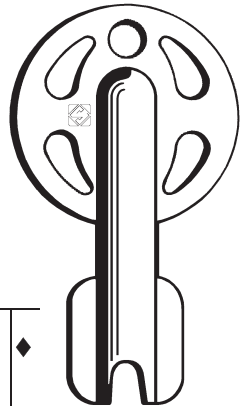
PER: FOR: ROMA	SABIEM	SAFOV
  ARO1	  ASAB1	  ASAF1 Modified/Modificato

PER: FOR: S.I.C.E.M	STIGLER - BELLOMO
  ASI1  ASI2	  AST1